



Tips for protecting your equipment



You too can help prolong the lifetime of your products. To succeed in this challenge, several aspects must be taken into account: product usage (intensity, frequency, conditions etc.), and also the transport, storage, care and maintenance.

Taking care with all of these aspects helps avoid premature wear of the equipment.

Here is a summary of precautions recommended by Petzl for maintaining your equipment.



Basic principles

- In general, take care of your safety gear. Do not leave it lying about anywhere. Do not throw your gear on the ground.
- Read the specific recommendations for each product in the Instructions For Use available on the Petzl Web site.
- See the heading "PPE* Inspection".

* PPE is Personal Protective Equipment, equipment worn or carried by the user. PPE are classified in three categories:

Category 1: minor hazards, light mechanical impacts, solar radiation (e.g. glasses, gloves)

Category 2: serious hazards (e.g. ventilated helmets, crampons)

Category 3: major or deadly hazards (e.g. harnesses, carabiners, ice axes)



Reminder of the lifetime of Petzl equipment.

- The maximum lifetime is up to 10 years from the date of manufacture for plastic and textile products.
- The lifetime is indefinite for metal products.
- Warning: An unusual event may require you to retire a product after only one use. This may involve the type and intensity of use, or the environment in which it is used: aggressive environments, sharp edges, extreme temperatures, chemicals...
- To learn more, see the heading "PPE Inspection".

How can I find out the age of my Petzl PPE?

All of our PPE products are now identified by a serial number. This number may be marked in a number of ways: laser, engraving, label, etc. It allows us to identify our products.

To find out the year of manufacture, refer to this detailed serial number in the following manner:

Example for recent PPE: 09 365 AB 1 234

09 year of manufacture
365 day of manufacture in that year
AB person who inspected the product
1234 individual product number

The oldest harnesses may be marked this way: 99 289 A

99 year of manufacture
289 day of manufacture in that year
A code of the person who inspected the product

Older connectors may be marked this way: 05 06

05 month of manufacture
06 year of manufacture

Transport

- It is preferable to store your equipment in a pack to protect it.
- With a backpack, take care that crampon points or sharp objects don't damage your helmet, ropes, or slings.
- When traveling by truck, train, plane, or boat, the temperatures can be extreme and can degrade the products. For example, never leave your textile equipment or helmets under a window or in the trunk of a car that is exposed to direct sunlight. The temperature can be higher than 80 °C.
- In the trunk of a car, for example, pay attention to your equipment's possible proximity to gas cans, car batteries, or cleaners (risk of leaking). Warning: any contact with chemical products, harsh or corrosive substances (e.g. acids) is prohibited. If you have a doubt, retire your equipment.

Storage

- Store your equipment in a well-ventilated area out of direct sunlight (UV).
- Reserve a specific place for your equipment. Warning: any contact with harsh or corrosive substances (e.g. acids) is prohibited. If you have a doubt, retire your equipment.
- Never store your gear in a damp place where mold can develop (damp closets, bags and waterproof containers with moisture inside). For long-distance travel, beware of moisture in containers during transit, in ports or airports, especially in salty environments.

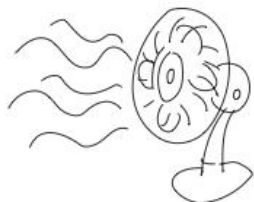

Repair

Modifications and repair of Petzl products outside of Petzl facilities is prohibited, except for replacing worn parts with replacement parts referenced in Petzl catalogs.

See the list of replacement parts at petzl.com

In case of doubt, contact After-sales service (aftersales@petzl.fr)

Washing

Recommendations for washing are indicated for each product family.

Drying

- Remove your gear from packs after each activity, even if cleaning isn't necessary.
- Let all your gear air-dry away from UV sources (ultraviolet rays).
- Avoid proximity to heat sources such as direct sunlight, wood fires, or a radiator.



30 C
maxi

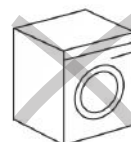

Maintenance

In general, when used in amateur sports, Petzl products do not require any special maintenance, outside of cleaning, except for metal products (see paragraphs: belay devices, descenders, carabiners, pulleys, ascenders, ice axes, crampons, ice screws).

Advice by product family

HELMETS

Care and maintenance tips

- You can personalize your helmet by writing (for example) your name, address, blood type, etc.
- Marking is authorized only on the comfort parts and not on the safety parts. You can use an adhesive tape or a tag attached with a cable tie. No paint! Refer to the recommendations in the Instructions For Use.
- Certain helmets have a place designed for transparent or reflective stickers. Use only stickers supplied by Petzl. They are available as spare parts.
- In case of heavy perspiration, protect the inside of the helmet with a head covering (e.g. bandana).
- Do not compress your helmet in a pack
- Do not sit on a helmet.

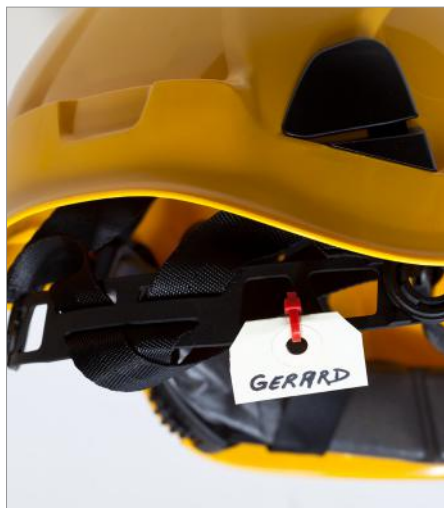

Maintenance

- After use in a salty environment (seaside), rinse with fresh water.
- Wash helmets in lukewarm soapy water (ph neutral, 30 °C maximum), then rinse thoroughly with fresh tap water.
- Use only household face and body soap. All other cleaning products, for example solvents, stain removers, degreasers, etc. are not compatible with polycarbonate, polystyrene, or nylon, and can weaken the helmet.
- The shell of ABS helmets can be cleaned with a cloth lightly moistened with rubbing alcohol. Warning, do not dip the helmet directly in alcohol.
- Do not use a high pressure water sprayer.

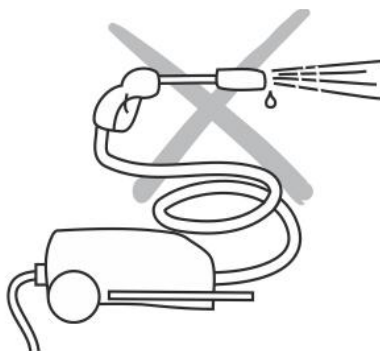

Repair

The headlamp clips and male part of the chinstrap buckle can be replaced. The comfort foams are available as replacement parts. All can be ordered from After-sales service: aftersales@petzl.fr or from the distributor in your country.



HARNESSES

Usage tips

- You can personalize your harness by writing (for example) your name, address, blood type, etc.
- Marking is authorized only on the labels and the comfort parts, and not on the safety parts. Refer to the recommendations in the Instructions For Use. A blank space is available on the harness label. You can also use cable ties.
- The chemical components of markers, paints, adhesive tapes, and stickers may be incompatible with nylon. These components can weaken the fibers and change the structure and strength of plastics. However, to mark a harness, you can use a small piece of adhesive tape on the comfort elements only. Make sure the marking does not interfere with proper usage.

When working at height on painting and/or spray coating operations, or in an oily environment, you can protect your harness with disposable coveralls. A hole can be cut in the coveralls with scissors to allow the lanyard to pass through.



Maintenance

- Regular cleaning preserves the legibility of identification, traceability, and standards markings. Additionally, it is easier to inspect the stitching and condition of the straps on a clean textile product.
- After use in a salty environment (seaside), rinse with fresh water.
- Wash harnesses in lukewarm soapy water (ph neutral, 30 °C maximum), then rinse thoroughly with fresh tap water.
- Use a small brush to remove stubborn spots (oily dirt or mud).
- You can wash your harness in a washing machine. Choose the 30 °C delicate synthetic setting, without spin cycle. Wash the harness inside a thick cloth bag to avoid damaging the machine drum with metal parts of harnesses.
- Use only household face and body soap. All other cleaning products, for example solvents, stain removers, degreasers, etc. are too strong and are incompatible with nylon and can damage the product.
- Do not use a high pressure water sprayer.
- Hang harnesses on a line to dry Do not use laundry detergent.

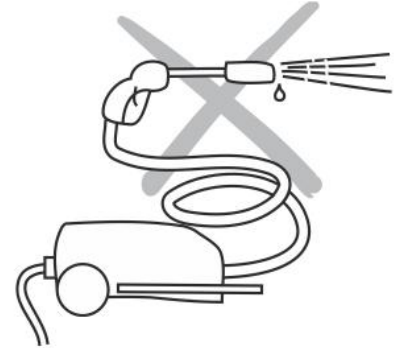

SLINGS, LANYARDS, AND ENERGY ABSORBERS

Usage tips

If you want to personalize your slings, lanyards and energy absorbers, know that the chemical components of markers, adhesive tapes, and stickers may be incompatible with nylon. Do not use markers on slings to avoid weakening them. You can write only on the marking tags or apply adhesive tape to the sewn termination covers.

To personalize your energy absorbers, you can write on the protective cover, or put a tag inside of it.



For certain lanyards, certain accessories can easily be replaced. For example the GRILLON lanyard rope, not having the same lifetime as metal products, can be easily replaced.

See the Instructions For Use of each product for more information.

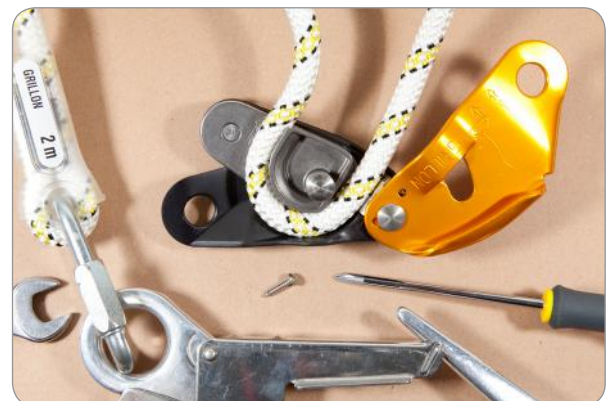

ROPES

Usage tips

- Do not walk on the ropes
- When tying-in repeatedly, tie into alternate ends of the rope on each pitch to avoid creating twists.
- Avoid descending too fast on a rope as this heats the sheath and accelerates wear (rappelling, or lowering a climber on top rope). During very rapid descents, a rappel device can become hot enough (230 °C) to melt the nylon fibers of the rope.
- Store your ropes in a proper bag that will protect them from dirt.
- Store ropes in bags, uncoiled. This avoids creating twists. Keep rope away from contact with sharp objects (ice screws, ice axes, crampons).
- Keep your ropes clean. A rope's condition can have an impact on the wear of other gear. For example, a muddy rope can inhibit the proper function of an ascender. A wet, sandy rope can cause premature wear of ascenders, descenders, and connectors.
- Mountaineering, especially in glaciated areas, canyoning and caving are practiced in extremely abrasive environments, laden with silt, water, and sand. Remember to rinse your ropes with water after use.
- Cutting rope:
 - Use a hot knife to obtain a neat, clean cut.
 - When cutting rope (new ropes on reels sold by the meter, or used ropes divided into multiple sections), you should mark each rope end with the appropriate information. At a minimum, write the diameter and new length of the rope.
 - Use labels or adhesive tape to record information on standards and protect the label with a heat-shrink sheath (WARNING: do not exceed 80 °C).

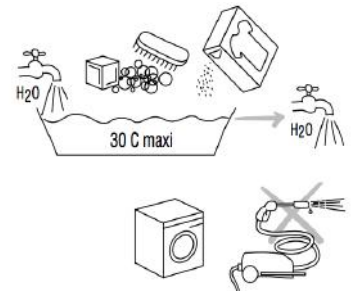

Required information on the label:

- The name of the manufacturer
- The type of rope.
- The CE mark with the number of the certifying body.
- The length.
- The diameter.
- The identification number containing the year of manufacture.
- The product model number.

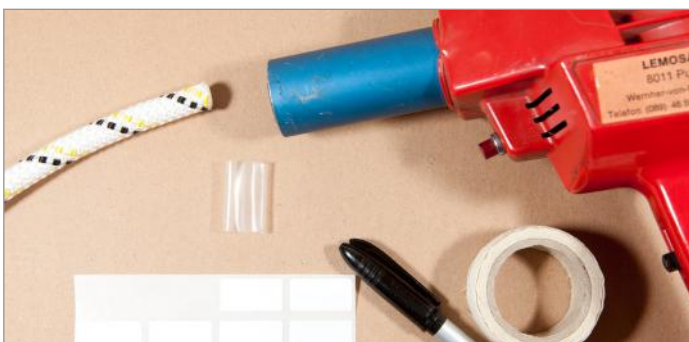
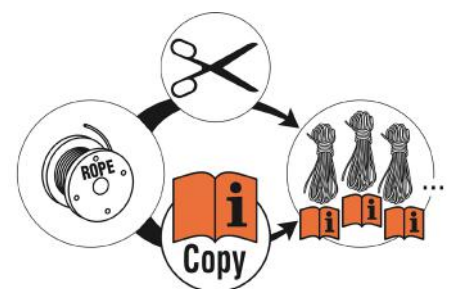

- To protect your ropes from abrasion, for example on edges, use PROTEC, CATERPILLAR, OR ROLL MODULE protectors.



Particulars of semi-static ropes:

Before the first use, soak a static rope in water for 24 hours.

This creates a better bond between the sheath and the core and helps remove lubricants (particularly slippery) used during manufacture.

Let the rope dry slowly. It will shrink by approximately 5 % (5 m for every 100 m). Take this into account in calculating the required length. A well-used rope can shrink up to an additional 5 %.

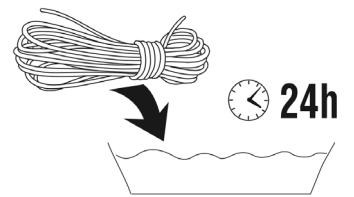

Maintenance

- After use in a salty environment (seaside), rinse with fresh water.
- Wash ropes in lukewarm soapy water (ph neutral, 30 °C maximum), then rinse thoroughly with fresh tap water.
- You can wash your rope in a washing machine. Choose the 30 °C delicate synthetic setting, without spin cycle.
- Use only household face and body soap. All other cleaning products, for example solvents, stain removers, degreasers, etc. are too strong and are incompatible with nylon.
- Do not use a high pressure water sprayer.

Metal equipment

Identification

Petzl metal products are marked with a laser engraving, a label, or a stamp indicating the model name, standards references and the serial number for traceability.

Usage tips

If you want to personalize your metal gear:

- Engraving a carabiner or other metal equipment is not recommended as this is a modification of the product that can weaken it. Do not use a stamp or punch. The use of stamps or punches is strictly prohibited, as this type of marking may affect product performance, depending on the depth, the force of impact, and the chosen area.
- However, you can use an electric engraving pen (depth less than 0.1 mm) on the frame, next to the serial number.
- You can also mark your metal equipment with a small amount of paint (paint pen or "metal writing" paint). Warning: do not dip your equipment in paint. Apply a small, thin marking of paint, not too thick.
- Do not mark any working areas. The marks must be made on a part of the body where there is no rubbing against another device, or rope. The marks must not hide the original marking (serial number, standards, etc.).
- This type of marking is prohibited on plastic pieces, as the chemical agents in paints can weaken the structure of plastics.
- As we cannot test every available paint, we advise you to choose a metal-compatible paint.

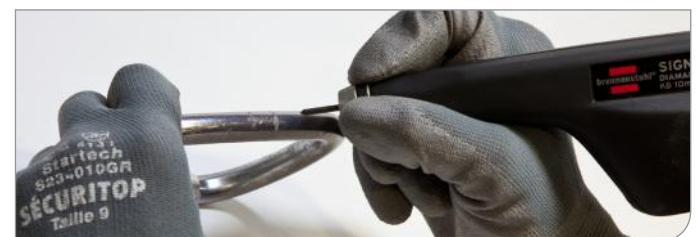

You can use adhesive tape on the areas where the rope does not run.



Maintenance

- After use in a salty environment (seaside), rinse with fresh water.
- Use a small brush to remove oily dirt or mud.
- Wash your gear in lukewarm soapy water (ph neutral, 30 °C maximum), then rinse thoroughly with fresh tap water.
- Do not use acid or harsh cleaners. Do not use WD 40 type degreasers as these products remove lubricants and their abrasive effect can accelerate wear.
- Certain metal gear also has plastic parts. Use only household face and body soap. All other cleaning products, for example solvents, stain removers, degreasers, etc. are too strong and not compatible with plastic materials.
- Do not use a high pressure water sprayer. High pressure water spray can remove lubricants and damage joints.
- If lubricating is necessary. Lubricate only with fluid oils (machine oil) or graphite powder. After lubricating, clean oil residue with a cloth to avoid getting oil on slings or ropes.

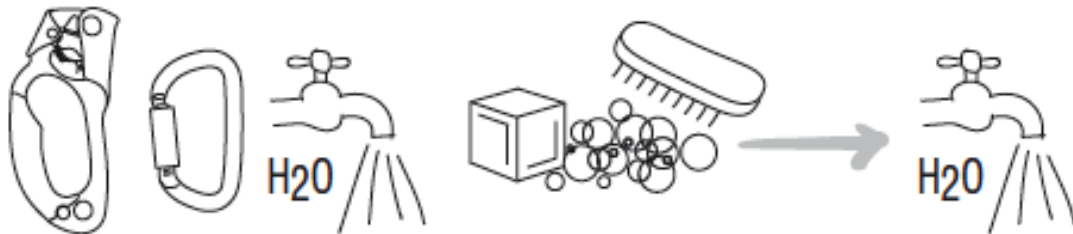
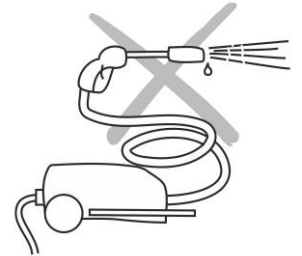

BELAY DEVICES, DESCENDERS

Maintenance

When a belay device has developed a sharp edge on the body, the Instructions For Use indicate that the product must be retired. In fact, we recommend retiring any metal product that has wear greater than one millimeter deep on its body. As with all descenders, the rope rubbing against the body of the REVERSO wears the metal.

To prolong the use of your descender, you can round sharp edges by hand (using fine grit sandpaper). The edge is thus less harmful to the rope. This operation can be done within the 1 millimeter limit.



The bobbins on the STOP and SIMPLE descenders are available as spare parts. They can be replaced when worn (see Instructions For Use).



CARABINERS

Maintenance

- Lubricate the hinge to restore spring action.
- After lubricating, clean oil residue with a cloth to avoid getting oil on slings or ropes.
- Do not use WD 40 as it can dry out the hinge and spring, thus accelerating aging.
- Do not use a high pressure water sprayer. A high pressure spray will dry out the gate hinge.



PULLEYS

Maintenance

- No specific lubrication is necessary as the sealed bearings are pre-lubricated and bushings are self-lubricating. In case of intensive usage, for example in adventure parks, or after use in water, you can use fluid oil (machine oil).
- Do not use WD 40 as it can dry out and damage the joints and bearings.
- Do not use a high pressure water sprayer. A high pressure spray can damage the joints and dry out the pulley by removing oil from self-lubricating bushings, or cause water to enter the sealed bearings.

ASCENDERS

Maintenance

Use a small brush to remove mud. For proper function and good grip on the rope, the teeth must be clean.

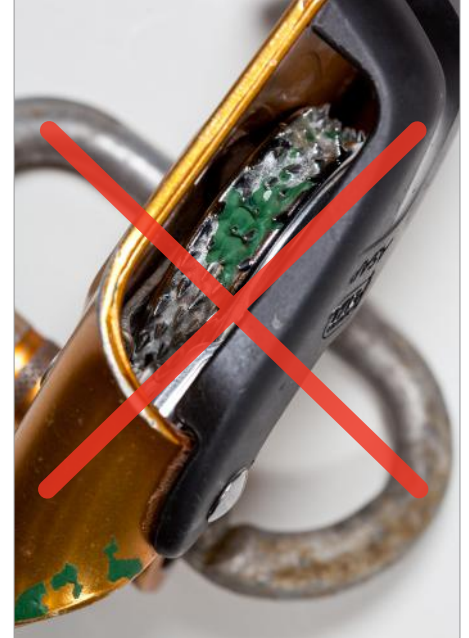

ICE AXES, CRAMPONS, ICE SCREWS

Usage tips

- Wipe ice axes and crampons with a dry cloth after use.
- Do not store crampons with wet slings.
- Remove and wipe the ice screw caps. Let ice screws dry completely.
- Carry ice screws in a protective case (ICEFLUTE) to avoid damaging the threads or dulling the cutting edges.



Maintenance

Rusting ice axe picks

- Ice axe picks are made of high strength steel without any rustproof treatment. After use, small traces of rust may appear. These traces do not affect the strength and do not lower the technical performance characteristics of your ice axe. To remove these traces of oxidation, you can rub the affected areas with an abrasive sponge. In using the ice axe, it is likely that these traces will disappear on their own.
- To reduce rust, it is recommended to wipe the ice axe pick with a dry cloth after each use. To better protect it, it is also recommended to coat it with oil or silicone grease.



Maintenance

Sharpening ice axes and crampons

- To remove picks, you can use a tube socket to facilitate loosening the nuts.
- File by hand to avoid heating which can affect the properties of the steel.
- Use a flat file for use with metal.
- It is necessary to cool the assembly frequently to avoid overheating and affecting the properties of the steel. The teeth will dull easily if they have been heated.

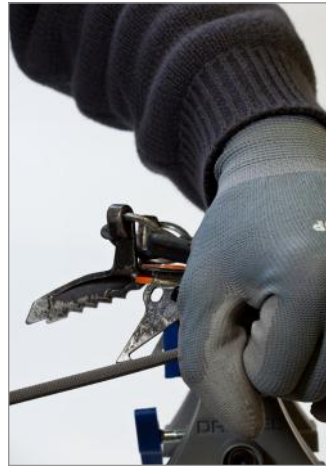
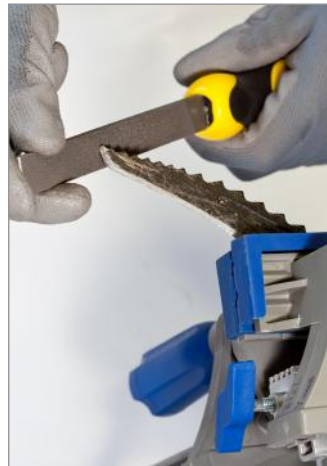

How to sharpen axe blades for climbing?

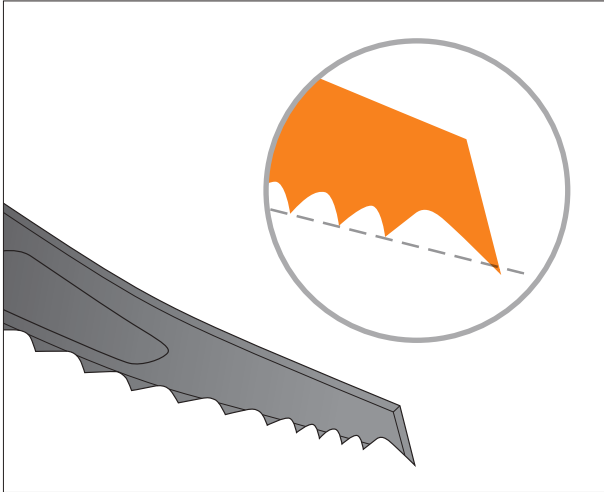

New pick

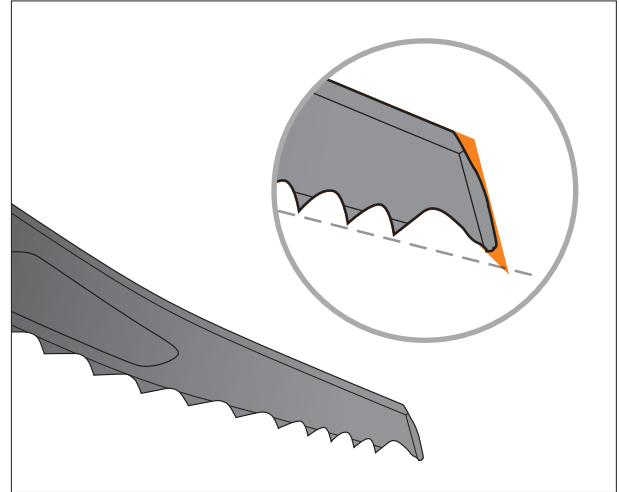

Pick in acceptable condition, to be sharpened.

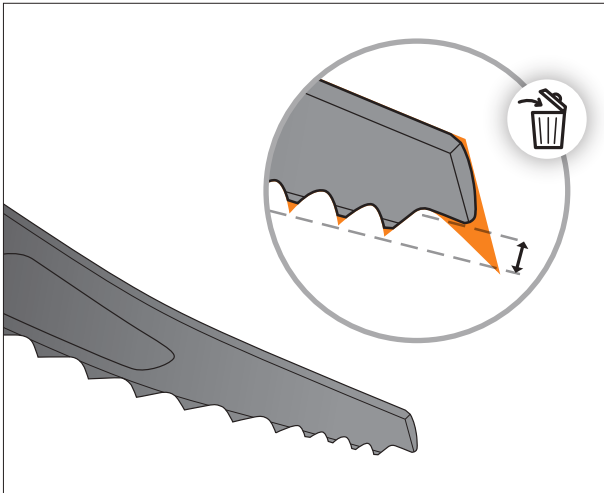

The first tooth is far too high (not hooked enough). To be retired.

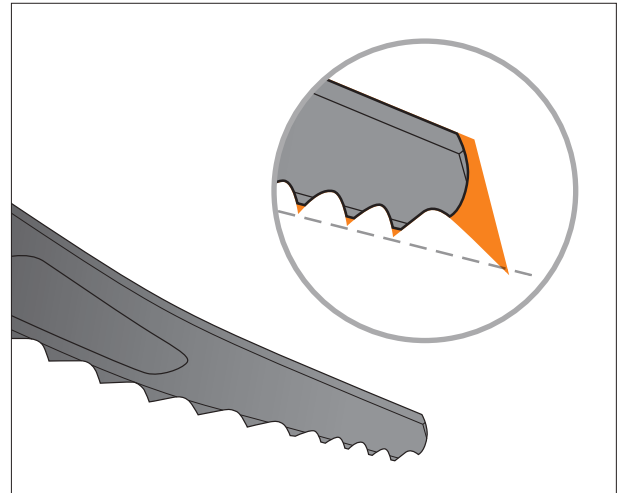

The first tooth is too worn. To be retired.

• Necessary equipment

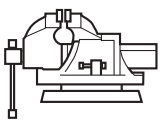

Vise

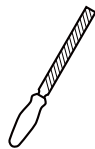

Flat file



Waterproof lubricant and cloth

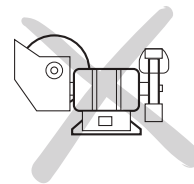

Grindstone prohibited

• Sharpening the pick

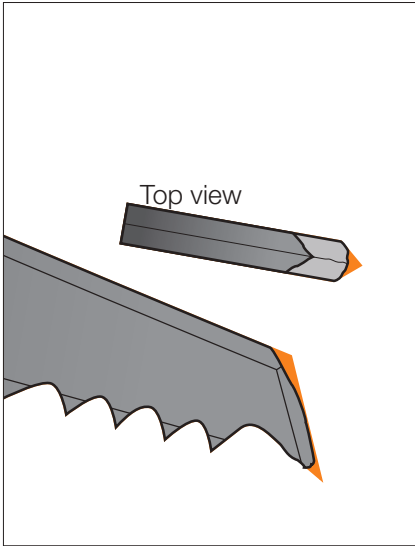

Pick before sharpening

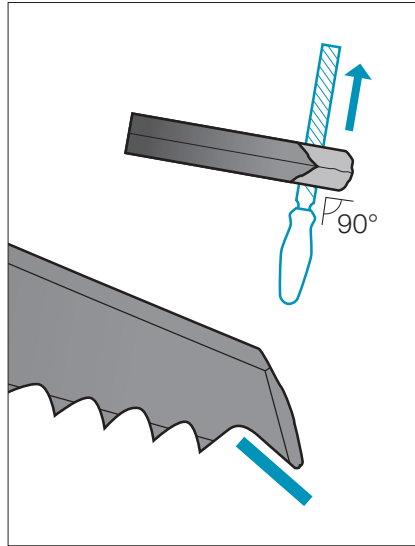

1- Straighten the side under the first tooth

Put the blade upside down in a vise. File very gently, carefully following the original angle of the pick, and filing perpendicular to it. Remove the least amount of metal possible to prolong the life of your pick.

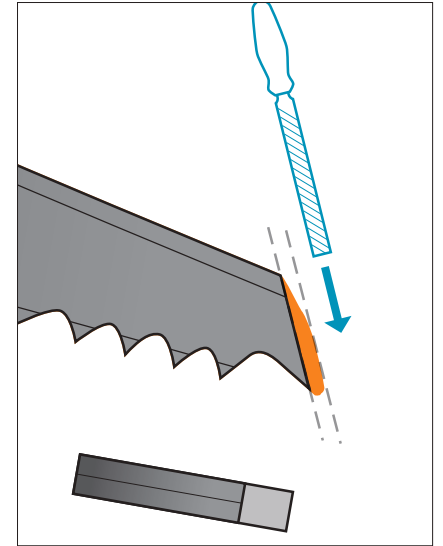

2- Restore the tip edge

File the edge of the tip to restore the original angle.

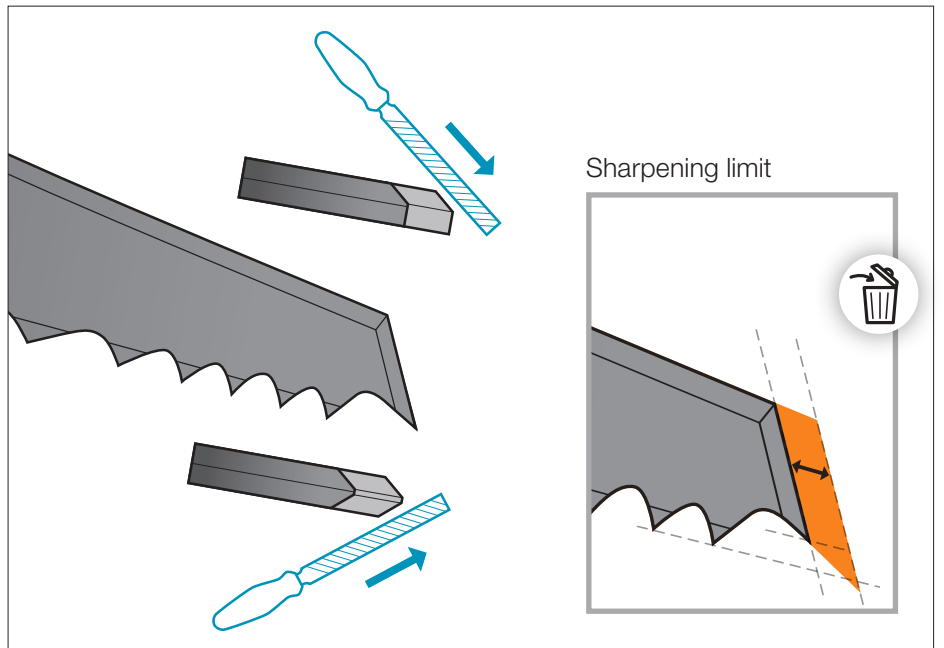

3- Restore the tip edge

Re-sharpen the beveled sides, without creating a sharp edge. Keep a thin (0.5 mm) flat area in the center. This will prolong the life of your pick without reducing its effectiveness.

Lightly lubricate the pick before storing, wipe off excess with a cloth.

Sharpening ice screws

- Use a fine file (flat file and 3 mm maximum round file). Take care not to damage adjacent teeth with a file that is too large.
- Secure the screw in a soft-jawed vice to preserve the threads.
- File only toward the outside of the screw.



Spare parts for ice axes and crampons

- Many spare parts are available for the ice climbing line:
 - Antibotts.
 - Ice axe picks, hammers and adzes.
- When replacing parts or accessories, follow the advice given in the Instructions For Use.
- You can download the list of spare parts (PDF format, 1.3 MB).

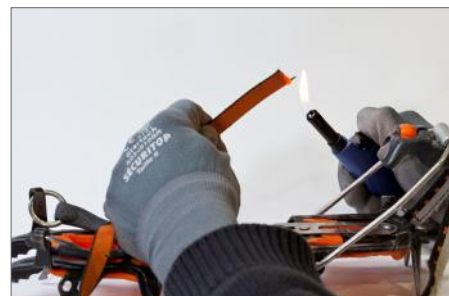

When replacing crampon straps, melt the ends.



HEADLAMPS

Read the specific recommendations for each lamp in the Instructions For Use and follow the battery compatibility recommendations.



Use

- Carry your headlamp in a specific pouch to protect the lens.
- After use, lock your lamp to avoid accidental switching on. The locking method is specific to each lamp.

Optimize the life of rechargeable batteries

- Completely charge a battery before first use.
- Do not submerge a rechargeable battery in water.
- After use in a wet environment, remove the rechargeable batteries and let them air-dry away from UV (ultraviolet rays). Avoid proximity to heat sources such as direct sunlight, wood fires, or a radiator.
- Remove the batteries for long term storage of the lamp. Store the batteries in a dry, well-ventilated area, out of direct sunlight.

Lithium ion batteries

- Petzl Lithium Ion batteries are guaranteed for one year or 300 charging cycles. They can be recharged 300 times (after 300 charge cycles, they will still have about 70 % of their initial capacity).
- Lithium Ion batteries lose 10 % of their capacity per year, whether they are used or not, independent of the number of cycles.
- The recharging temperature of a Lithium Ion battery must be between 0 °C and +40 °C to avoid any deterioration.
 - Avoid, for example, recharging a battery with a car charger, under a windshield exposed to direct sunlight.
 - Do not charge a battery inside an enclosure (e.g. a case or box) as this can cause overheating that can damage the battery.
- The use and storage temperature of a Lithium Ion battery must be between -30 °C and +50 °C to avoid any deterioration.
- For the ATEX lamps, the use and storage temperature must be between -30 °C and +40 °C.
- The ideal ambient temperature for recharging, use, and storage of a Lithium Ion battery is about 20 °C.

- A negative temperature below 0 °C reduces the lamp's battery life because the faster discharge dims the light output. However, these are temporary drawbacks. Once the Lithium Ion molecules are re-warmed, the battery regains its previous capacity.
- Elevated temperatures above 50 °C can permanently damage batteries. However, this doesn't happen instantly; repeated use at elevated temperatures must occur to cause damage. Never leave your headlamp under a windshield, a window, or in a trunk if the outside temperature is elevated.



Nickel cadmium (Ni-Cd) and nickel metal hydride (Ni-MH) batteries

- Petzl Ni-MH batteries can be recharged 500 times.
- **WARNING**, completely discharging a Ni-MH rechargeable battery may affect its performance, possibly resulting in the emission of gases and toxic materials. Do not hesitate to recharge a battery that is partially discharged or that has been in storage for more than two weeks.
- Self-discharge in prolonged storage: nickel batteries lose at least 10 % of their capacity after the first day of non-use, then about 20 % per month.
- Nickel batteries must always be charged at a temperature between 10 °C and 40 °C.
- Always use your batteries at a temperature between -20 °C and +60 °C.
- Store your batteries at temperatures between -20 °C and +35 °C.



Maintenance

- After use in a muddy or salty (seaside) environment, rinse with fresh water.
- Remove the batteries.
- Dry the lamp with the battery case open.
- Do not close the battery case of a waterproof lamp with moisture inside.
- Wash the outside of the lamp (lamp head and lens) with lukewarm soapy water (ph neutral, 30 °C maximum).
- Wipe the lens with a soft cloth. Do not wipe the lens with an abrasive product.
- Avoid any prolonged contact of grease with the lens. In case of contact with grease, wipe with a dry cloth and rinse with water.
- Remove and wash the elastic straps in the washing machine, treating as a delicate fabric, without spin cycle.
- The comfort foams are available as replacement parts.

Maintenance, repair

Never dismantle a lamp except to replace the correct spare parts, referenced in Petzl catalogs. These components must be identical to the original parts and be sold with their Instructions For Use.

Retiring products at the end of their lifetime

For your safety, make sure to retire your gear when necessary.

A product must be retired when:

- It is over 10 years old and made of plastic or textiles
- It has been subjected to a major fall or load
- It fails to pass inspection
- Its reliability is in question
- Its entire history is not known (e.g. found or second-hand product)
- When it becomes obsolete due to changes in legislation, standards, technique or incompatibility with other equipment, etc.

Warning: destroy retired equipment to prevent further use.

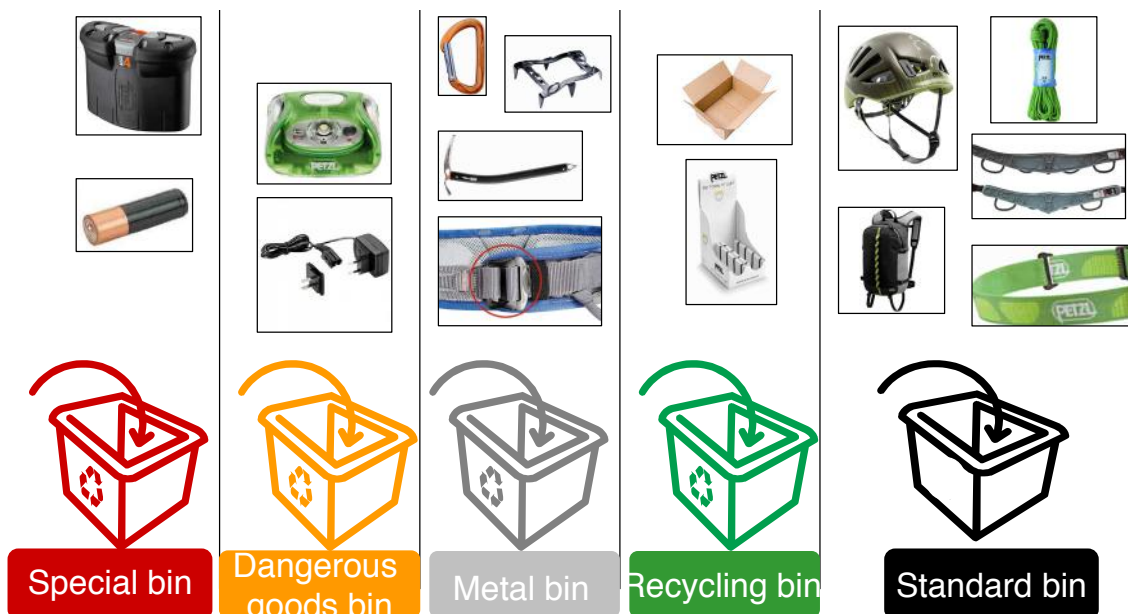

Petzl is working on alternative solutions for the treatment of retired products, for better recycling of materials.

Petzl contact

Petzl International

132 rue du Pré Blanc
Cidex 105A - ZI Crolles
38920 Crolles - FRANCE

Tel: +33 (0)4 76 92 09 69

Fax: +33(0)4 76 08 82 04

Photos Petzl © Lafouche



Photo Petzl © Kalice